

HDL-MR0420C.431
 4CH 20A High Power Switch Actuator with Current Detection
 HDL-MR0820C.432
 8CH 20A High Power Switch Actuator with Current Detection
 HDL-MR1220C.433
 12CH 20A High Power Switch Actuator with Current Detection

buspro

Datasheet

Issued: May 6, 2021

File Edition: B



Figure 1. HDL-MR0420C.431



Figure 2. HDL-MR0820C.432



Figure 3. HDL-MR1220C.433

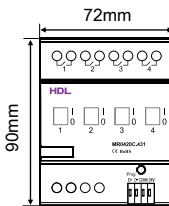

Figure 4. Dimensions - Front View

HDL-MR0420C.431

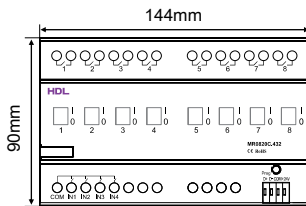

Figure 5. Dimensions - Front View

HDL-MR0820C.432

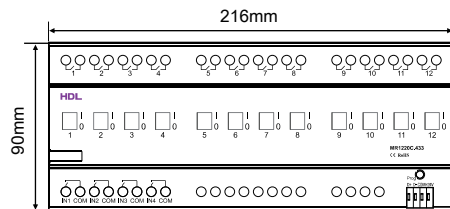

Figure 6. Dimensions - Front View

HDL-MR1220C.433

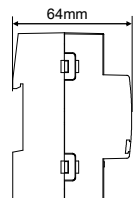

Figure 7. Dimensions - Side View

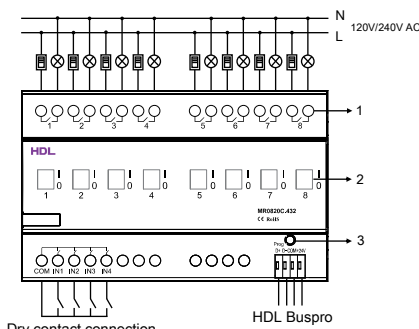

Figure 8. Wiring
 HDL-MR0820C.432

Overview

4/8/12CH 20A High Power Switch Actuator with Current Detection (See Figure 1-3) has 4/8/12 channels with current detection function (20A for each channel) and 50A magnetic latching relay. With low power consumption and long lifetime, the module has manual control switches and supports scene and sequence control.

Its main features include:

- 4/8/12-channel relay output unit
- Scene control and sequence control
- Up to 4/8/12 separate zones
- 4/8/12 scenes for each zone, scene running time up to 60 minutes
- 2 sequences for each zone, up to 4/8/12 steps for each sequence
- Light protection delay for each channel (0-60 minutes)
- Mass turn-on delay for each channel (0-25 seconds)
- Manual switch for each channel
- Stair lamp function of the channel settable
- Channel current, used time of load and alarm status of each channel can be detected.
- Selected scene or scene before power off automatically activated when device restarts
- 8/12CH 20A High Power Switch Actuator with Current Detection has 4 dry contacts, supports the functions of long-press dimming and short-press triggering target.
- Easy programming
- Health detection
- 4/8/12-channel current detection, alarm message push function
- HDL Buspro communication
- Supports online update

Components and Operation

Dimensions - See Figure 4 - 7

Wiring - See Figure 8 - 9 (Take the connection of HDL-MR08(12)20C.432(433) as examples)

1. Connect to load
2. Bypass switch
3. Programming button & module indicator

The indicator flashes when device is in normal working mode. Press the button for 3 seconds, then the ID can be read and modified via HDL Buspro Setup Tool.

Note(s)

- Buspro cable - CAT5E or dedicated HDL Buspro cable
- Buspro connection - Series connection (hand-in-hand recommended).
- Maximum current of each output channel: 20A
- One 20A breaker for each channel for protection

⚠ Safety Precautions

- The installation and testing for the product must be carried out by HDL Automation Co., Ltd. or its appointed service agencies. The electric construction shall comply with local laws and safety regulations.
- The device should be installed with DIN rail in DB box. HDL will not be responsible for any consequence caused by the inexpert or faulty installation and wiring methods, which are not in accordance with the instructions contained in this operating instruction.
- Please do not privately disassemble or replace any parts of the product. Otherwise, it may cause mechanical fault, electric shock, fire or personal injuries.
- Please contact our after-sales departments or our designated service agencies for your maintenance service. Product failures caused by private disassembly are not subject to this warranty.
- It is not allowed to exceed the range.

Package Contents

Device*1 / Label*5 / Buspro connector*1 / Datasheet*1

Technical Data

Basic Parameters

Working voltage	24~30V DC
Working current	38mA/24V DC
Input voltage	120V/240V AC (50/60Hz)
Output channel	HDL-MR0420C.431: 4CH, 20A/CH HDL-MR0820C.432: 8CH, 20A/CH HDL-MR1220C.433: 12CH, 20A/CH
Relay	50A magnetic latching relay
Maximum current of each channel	20A
Electronic life time of relay	>60000 (Resistance load)
Protection	Connect a breaker in each channel
Communication	HDL Buspro

External Environment

Working temperature	-5°C~45°C
Working relative humidity	≤90%
Storage temperature	-20°C~60°C
Storage relative humidity	≤93%

Specifications

Dimensions	HDL-MR0420C.431: 72mm×90mm×64mm HDL-MR0820C.432: 144mm×90mm×64mm HDL-MR1220C.433: 216mm×90mm×64mm
Net weight	HDL-MR0420C.431: 256g HDL-MR0820C.432: 575g HDL-MR1220C.433: 804g
Housing material	Flame retardant nylon
Installation	35mm DIN rail installation (See Figure 10 - 12)
Protection rating (Compliant with EN 60529)	IP20

Recommended Load Types and Power

240V, 20A, Resistive, 100,000 cycles, 40°C;
240V, 20FLA/96LRA, Motor, 30,000 cycles, 40°C;
240V, 20A, Standard Ballast, 30,000 cycles, 40°C;
240V, 20A, Electronic Ballast, 6,000 cycles, 40°C;
120V, 20FLA/96LRA, Motor, 30,000 cycles, 40°C;
120V, 20A, Electronic Ballast, 6,000 cycles, 40°C;
120V, 20A, Standard Ballast, 30,000 cycles, 40°C;

Approved

CE
RoHS

HDL Buspro Cable Guide

HDL Buspro	HDL Buspro Cable	CAT5/CAT5E
DATA+	Yellow	Blue/Green
DATA-	White	Blue white/Green white
COM	Black	Brown white/Orange white
24V DC	Red	Brown/Orange

Installation

Installation - See Figure 10 - 12 (Take HDL-MR1220C.433 as an example)

- Step 1. Fix the DIN rail with screws.
- Step 2. Buckle the bottom cap of the actuator on the edge of the DIN rail.
- Step 3. Press the device on the DIN rail, slide it and fix it up until an appropriate position is adjusted.

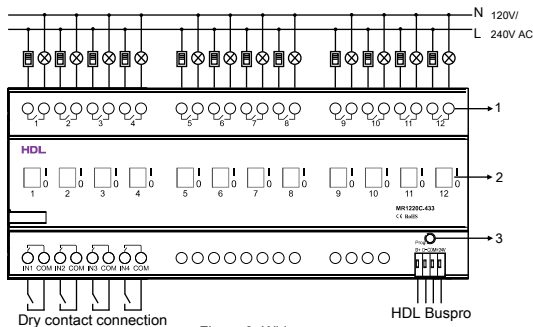

Figure 9. Wiring
HDL-MR1220C.433



Figure 10

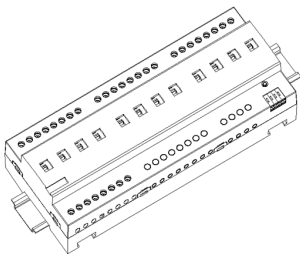

Figure 11

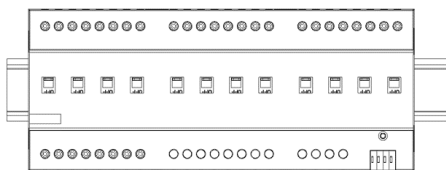

Figure 12

Figure 10 - 12. Installation

Technical support

E-mail: hdtickets@hdlautomation.com
Website: <https://www.hdlautomation.com>

©Copyright by HDL Automation Co., Ltd. All rights reserved.
Specifications subject to change without notice.